



CARRADIO-SIGNAL-PROCESSOR

- 4 STEREO INPUTS
- SOFT STEP-VOLUME
- BASS, TREBLE AND LOUDNESS CONTROL
- DIRECT MUTE AND SOFT MUTE
- INTERNAL BEEP
- FOUR INDEPENDENT SPEAKER-OUTPUTS
- SUBWOOFER STEREO OUTPUT
- DIGITAL CONTROL:
 - I²C-BUS INTERFACE
 - AUDIO-FILTER CHARACTERISTICS PROGRAMMABLE

DESCRIPTION

The TDA7409 is a high performance signal processor specifically designed for car radio applications. The device includes a high performance audioprocessor with fully integrated audio filters. The digital control allows a programming in a wide range of all the filter characteristics. By the use of a BICMOS-

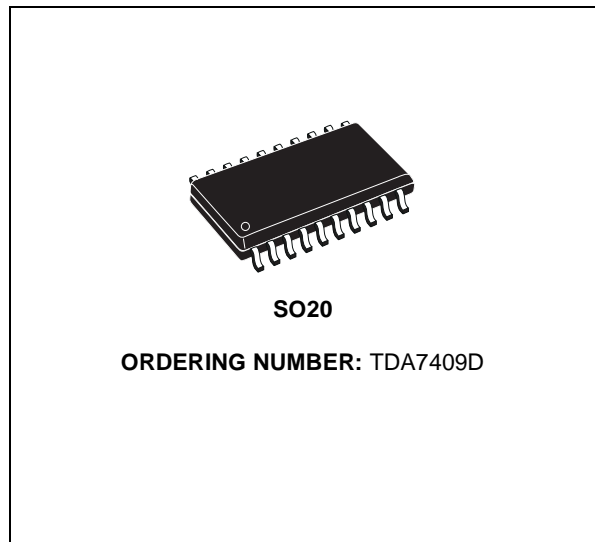

process and a linear signal processing low distortion and low noise are obtained.

BLOCK DIAGRAM

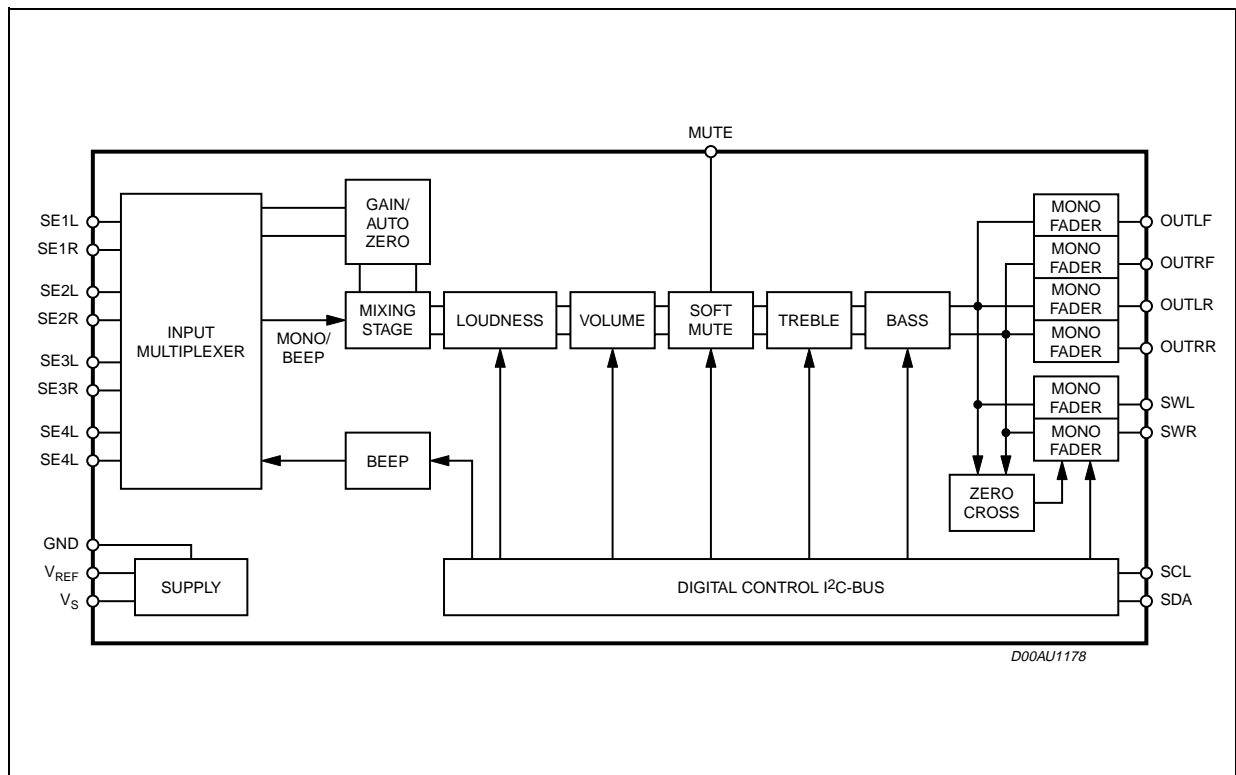

TDA7409

SUPPLY

Symbol	Parameter	Test Condition	Min.	Typ.	Max.	Unit
V_s	Supply Voltage		7.5	9	10.5	V
I_s	Supply Current	$V_s = 9V$		20		mA
SVRR	Ripple Rejection @ 1KHz	Audioprocessor(all Filters flat)		60		dB

THERMAL DATA

Symbol	Parameter	Value	Unit
$R_{Th\ j-pins}$	Thermal Resistance Junction-pins max	85	°C/W

ABSOLUTE MAXIMUM RATINGS

Symbol	Parameter	Value	Unit
V_s	Operating Supply Voltage	10.8	V
T_{amb}	Operating Temperature Range	-40 to 85	°C
T_{stg}	Storage Temperature Range	-55 to +150	°C

ESD

All pins are protected against ESD according to the MIL883 standard.

PIN CONNECTION

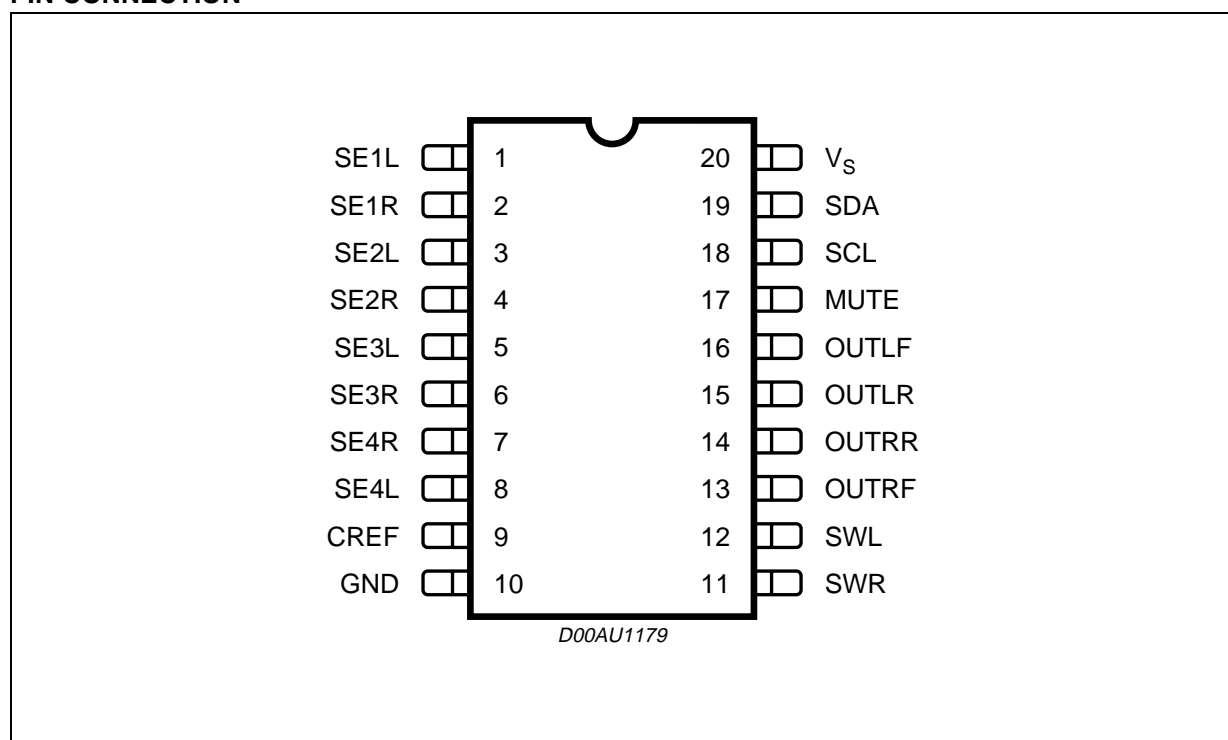

FEATURES:

Input Multiplexer	4 single-end stereo inputs In-Gain 0..14dB, 1dB steps, 14..20dB, 2dB steps Auto Zero
Beep	internal Beep with 3 frequencies 781Hz/1.56KHz/1.8KHz
Mixing stage	4 step-mixing-stage with mono or beep as mix-signals
Loudness	second order frequency response programmable center frequency 15 x 1dB steps selectable low & high frequency boost selectable flat-mode (constant sttenuation)
Volume	1 dB attenuator 100dB range soft-step control with programmable times
Bass	2nd order frequency response center frequency programmable in 4 steps 60Hz/80Hz/100Hz/200Hz Q programmable 1.0/1.25/1.5/2.0 DC gain programmable $\pm 15\text{dB} \times 1\text{dB steps}$
Treble	2nd order frequency response center frequency programmable in 4 steps 10KHz/12.5KHz/15KHz/17.5KHz $\pm 15\text{dB} \times 1\text{dB steps}$
Speaker	4 independent speaker controls in 1dB steps control range 50dB with mute Zero crossing attenuate
Subwoofer	Stereo output attenuator range 50dB
Mute Functions	direct mute digitally controlled Soft Mute with 4 programmable mute-times

TDA7409

ELECTRICAL CHARACTERISTICS ($V_S=9V$; $T_{AMB}=25$; $R_L=10k\Omega$; all gains = 0dB; $f = 1kHz$; unless otherwise specified)

Symbol	Parameter	Test Conditions	Min.	Typ.	Max.	Unit
--------	-----------	-----------------	------	------	------	------

INPUT SELECTOR

R_{in}	Input Resistance	all single ended Inputs	70	100	130	$k\Omega$
V_{CL}	Clipping Level		2.20	2.60		V_{RMS}
S_{IN}	Input Separation		80	100		dB
$G_{IN MIN}$	Min. Input Gain		-1	0	1	dB
$G_{IN MAX}$	Max. Input Gain		18	20	22	dB
G_{STEP}	Step Resolution		0.5	1	1.5	dB
V_{DC}	DC Steps	Adjacent Gain Steps	-5	1	5	mV
		G_{MIN} to G_{MAX}	-10	5	10	mV
V_{offset}	Remaining offset with AutoZero			0.5		mV

BEEP CONTROL

V_{RMS}	Beep Level		250	350	500	mV
f_B	Beep Frequency	f_{B1}	740	781	820	Hz
		f_{B2}	1.48	1.56	1.64	kHz
		f_{B3}	1.7	1.8	1.9	kHz

MIXING CONTROL

M_{LEVEL}	Mixing Level	Main / Mix-Source		0/00		dB
		Main / Mix-Source	-0.5/-10.6	-3.5/-9.6	-2.5/-8.6	dB
		Main / Mix-Source	-5/-5	-6/-6	-7/-7	dB
		Main / Mix-Source	-11/-1.5	-12/-2.5	-13/-3.5	dB

VOLUME CONTROL

G_{MAX}	Max. Gain		28	30	32	dB
A_{MAX}	Max. Attenuation		-83	-79	-75	dB
A_{STEP}	Step Resolution		0.5	1	1.5	dB
E_A	Attenuation Set Error	$G = -20$ to $+20$ dB	-1	0	1	dB
		$G = -80$ to -20 dB	-4	0	3	dB
E_T	Tracking Error				2	dB

ELECTRICAL CHARACTERISTICS (continued)

Symbol	Parameter	Test Conditions	Min.	Typ.	Max.	Unit
V _{DC}	DC Steps	Adjacent Steps		0.1	3	mV
		From 0dB to G _{MIN}		0.5	5	mV

LOUDNESS CONTROL

A _{STEP}	Step Resolution		0.5	1	1.5	dB
A _{MAX}	Max. Attenuation		13	15	17	dB
f _C	Center Frequency		360	400	440	Hz
			720	800	880	Hz
			2.3	2.4 ¹	2.5	kHz

SOFT MUTE

A _{MUTE}	Mute Attenuation		80	100		dB
T _D	Delay Time	T1		0.48	1	ms
		T2		0.96	2	ms
		T3	20	30.7	50	ms
		T4	70	123	170	ms
V _{TH low}	Low Threshold for SM-Pin ²				1	V
V _{TH high}	High Threshold for SM - Pin		2.50			V
R _{PU}	Internal pull-up resistor		70	100	130	kΩ
V _{PU}	Pull-Up Voltage			5		V

SOFT STEP

T _{SW}	Switch time	T _{SW1}		0.68		ms
		T _{SW2}		1.26		ms
		T _{SW3}		2.52		ms
		T _{SW4}		5.04		ms

1) Center frequency 2.4KHz makes 1KHz bottom frequency at low & high frequency boost condition.

2) The SM-Pin is active low (Mute = 0)

BASS CONTROL

C _{RANGE}	Control Range		±14	±15	±16	dB
A _{STEP}	Step Resolution		0.5	1	1.5	dB
f _C	Center Frequency	f _{C1}	54	60	66	Hz
		f _{C2}	72	80	88	Hz
		f _{C3}	90	100	110	Hz
		f _{C4}	180	200	220	Hz

ELECTRICAL CHARACTERISTICS (continued)

Symbol	Parameter	Test Conditions	Min.	Typ.	Max.	Unit
Q _{BASS}	Quality Factor	Q ₁	0.9	1	1.1	
		Q ₂	1.1	1.25	1.4	
		Q ₃	1.3	1.5	1.7	
		Q ₄	1.8	2	2.2	
DC _{GAIN}	Bass-DC-Gain	DC = off	-1	0	1	dB
		DC = on	4	4.4	6	dB

TREBLE CONTROL

C _{RANGE}	Control Range		±14	±15	±16	dB
A _{STEP}	Step Resolution		0.5	1	1.5	dB
f _C	Center Frequency	f _{C1}	8	10	12	kHz
		f _{C2}	10	12.5	15	kHz
		f _{C3}	12	15	18	kHz
		f _{C4}	14	17.5	21	kHz

SPEAKER ATTENUATORS

C _{RANGE}	Control Range		-53	50	-47	dB
A _{STEP}	Step Resolution	only for attenuation up to 24dB	0.5	1	1.5	dB
A _{MUTE}	Output Mute Attenuation		80	90		dB
E _E	Attenuation Set Error		-2		2	dB
V _{DC}	DC Steps	Adjacent Attenuation Steps		0.10	5	mV
T _{ZC}	Zero Cross Timer	Data bit D1=1 , D2=1	29	37	45	ms
V _{th}	Zero Cross Threshold			±20		mV

FADER OUTPUTS

V _{CLIP}	Clipping Level	d = 0.3%	2.20	2.60		V _{RMS}
R _L	Output Load Resistance		2			kΩ
C _L	Output Load Capacitance				10	nF
R _{OUT}	Output Impedance			30	100	Ω
V _{DC}	DC Voltage Level		4.3	4.5	4.7	V

SUBWOOFER ATTENUATORS

C _{RANGE}	Control Range		-53	50	-47	dB
A _{STEP}	Step Resolution		0.5	1	1.5	dB
A _{MUTE}	Output Mute Attenuation		80	90		dB

ELECTRICAL CHARACTERISTICS (continued)

Symbol	Parameter	Test Conditions	Min.	Typ.	Max.	Unit
E_E	Attenuation Set Error				2	dB
V_{DC}	DC Steps	Adjacent Attenuation Steps		0.10	5	mV

GENERAL

e_{NO}	Output Noise	BW = 20Hz - 20kHz all gains = 0dB single ended inputs		10	15	μ V
S/N	Signal to Noise Ratio	all gains = 0dB flat; $V_O = 2V_{RMS}$		106		dB
		bass, treble at +12dB; a-weighted; $V_O = 2.6V_{RMS}$		100		dB
d	Distortion	$V_{IN} = 1V_{RMS}$; all stages 0dB internal pass only		0.005	0.1	%
		$V_{OUT} = 1V_{RMS}$; Bass & Treble = 12dB		0.05	0.1	%
S_C	Channel Separation left/right		80	100		dB
E_T	Total Tracking Error	$A_V = 0$ to -20dB	-1	0	1	dB
		$A_V = -20$ to -60dB	-2	0	2	dB

1.0 DESCRIPTION OF FUNCTIONALITY

1.1 Input stages

The input stages have remained the same as in preceding ST-Audioprocessors.

Figure 1. Input-stages

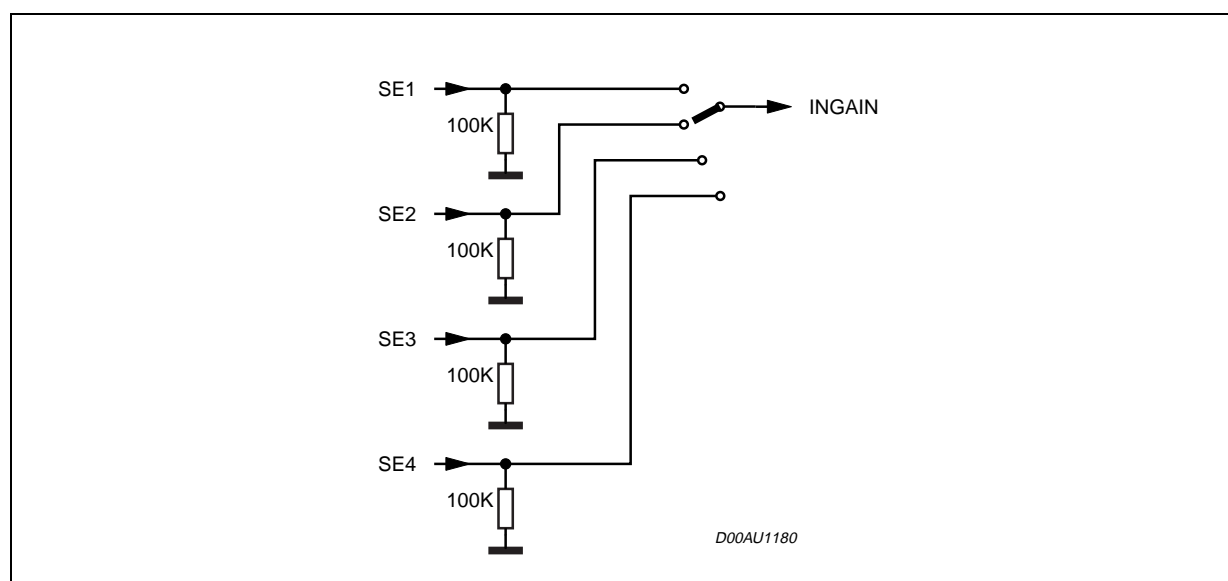

1.2 AutoZero

In order to reduce the number of pins there is no AC coupling between the In-Gain and the following stage, so that any offset generated by or before the In-Gain-stage would be transferred or even amplified to the output. To avoid that effect a special Offset-cancellation-stage called AutoZero is implemented. This stage is located before the Mixing-block to eliminate all offsets generated by the Input-Stages and the In-Gain (Please notice that externally generated offsets, e.g. generated through the leakage current of the coupling capacitors, are not canceled).

The auto-zeroing is started every time the DATA-BYTE 0 (Input Selector/Gain) is selected and takes a time of max. **0.3ms**. To avoid audible clicks the Audioprocessor is muted before the loudness stage during this time.

1.2.1 AutoZero-Remain

In some cases, for example if the uP is executing a refresh cycle of the IIC-Bus-programming, it is not useful to start a new AutoZero-action because no new source is selected and an undesired mute would appear at the outputs. For such applications the TDA7409 could be switched in the **AutoZero-Remain-Mode** (12 bit of the subaddress-byte). If this bit is set to high, the DATABYTE 0 could be loaded without invoking the AutoZero and the old adjustment-value remains.

1.3 Mixing Stage

The 4 step Mixing stage offers the possibility to mix the rear selector signal or the phone signal to any other source. Due to the fact that the mixing-stage is located behind the In-Gain-stage fine adjustments of the main source level could be done in this way.

Figure 2. Signal-Flow of Mixing-Stage

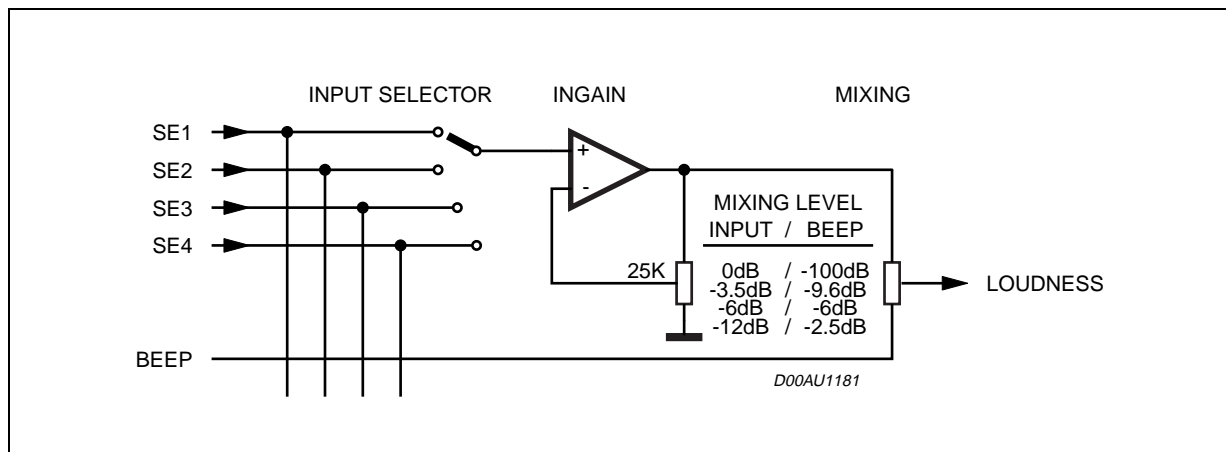

1.4 Loudness

There are four parameters programmable in the loudness stage:

1.4.1 Attenuation

Figure 3 shows the attenuation as a function of frequency at $f_c = 400\text{Hz}$.

Figure 3. Loudness Attenuation @ $f_c = 400\text{Hz}$

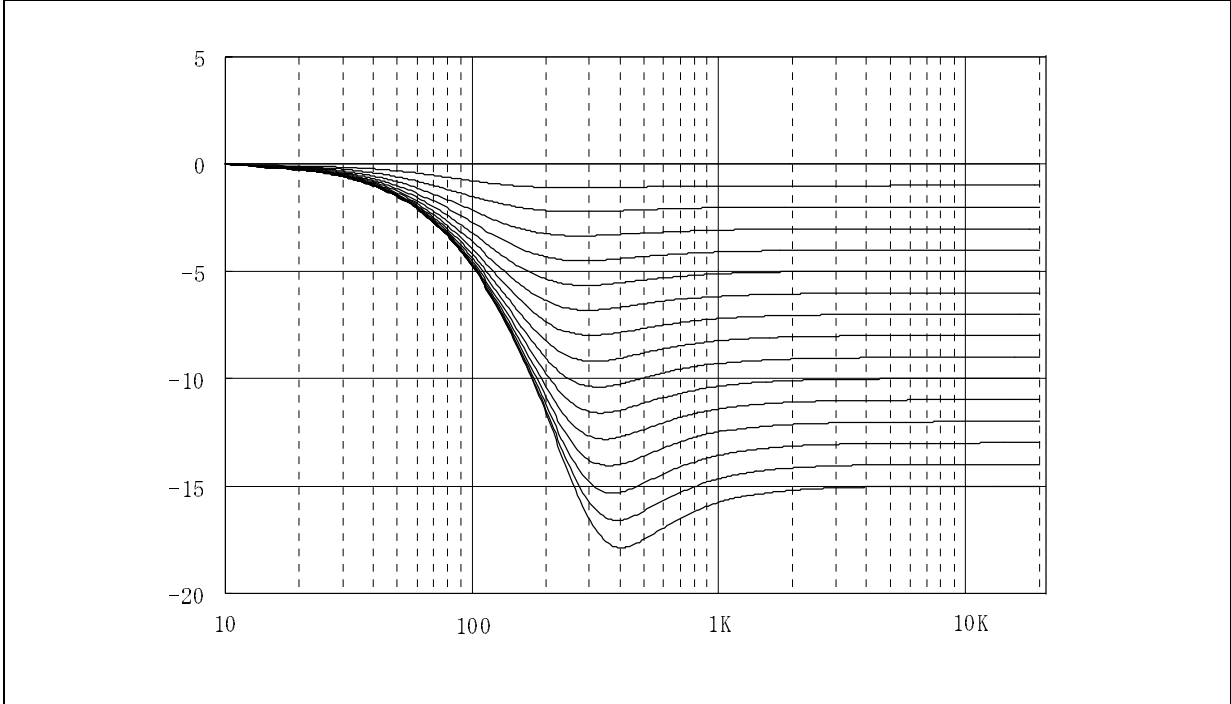

1.4.2 Center Frequency

Figure 4 shows the three possible peak-frequencies 400Hz , 800Hz and 2.4kHz.

Figure 4. Loudness Center frequencies @ Attn. = 15dB

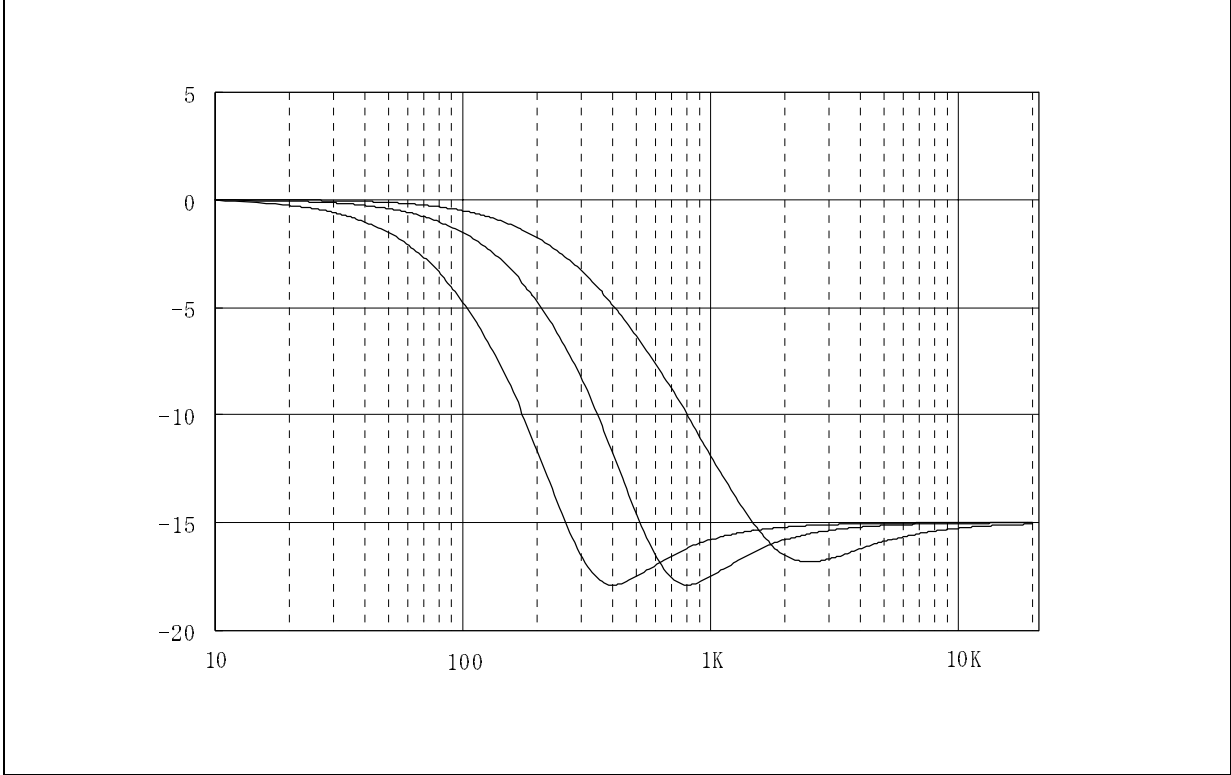

1.4.3 Low & High Frequency Boost

Figure 5 shows the different Loudness-shapes in low & high frequency boost.

Figure 5. Loudness Attenuation , $f_c = 2.4\text{KHz}$

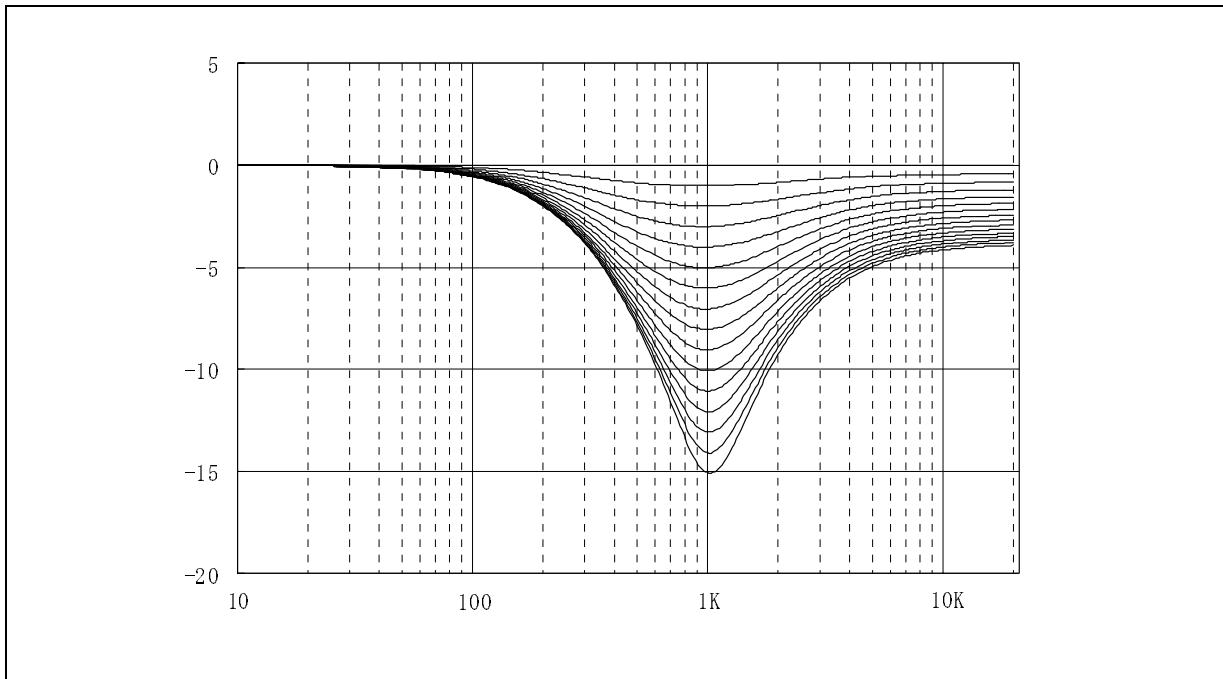

1.5 SoftMute

The digitally controlled SoftMute stage allows muting/demuting the signal with a I2C-bus programmable slope. The mute process can either be activated by the Mute pin or by the I2C-bus. This slope is realized in a special S-shaped curve to mute slow in the critical regions (see Figure 6).

For timing purposes the Bit 0 of the I2C-bus output register is set to 1 from the start of muting until the end of de-muting.

Figure 6. Softmute-Timing

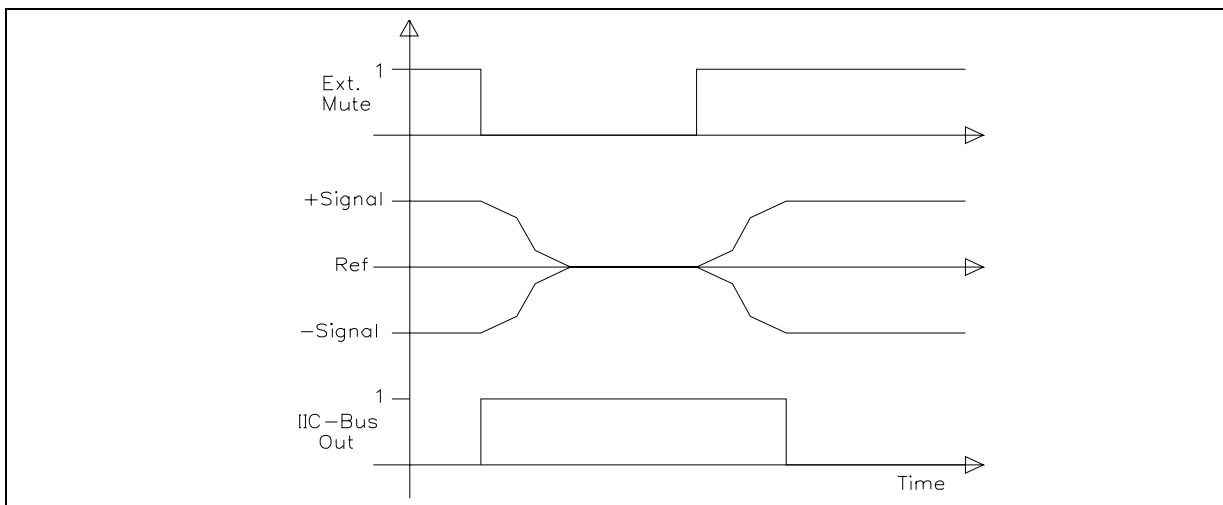

Note: Please notice that a started Mute-action is always terminated and could not be interrupted by a change of the mute -signal.

1.6 SoftStep-Volume

When the volume-level is changed audible clicks could appear at the output. The root cause of those clicks could either be a DC-Offset before the volume-stage or the sudden change of the envelope of the audiosignal. With the SoftStep-feature both kinds of clicks could be reduced to a minimum and are no more audible. Four programmable soft step time from one step to the next, are user selectable.

Figure 7. SoftStep-Timing

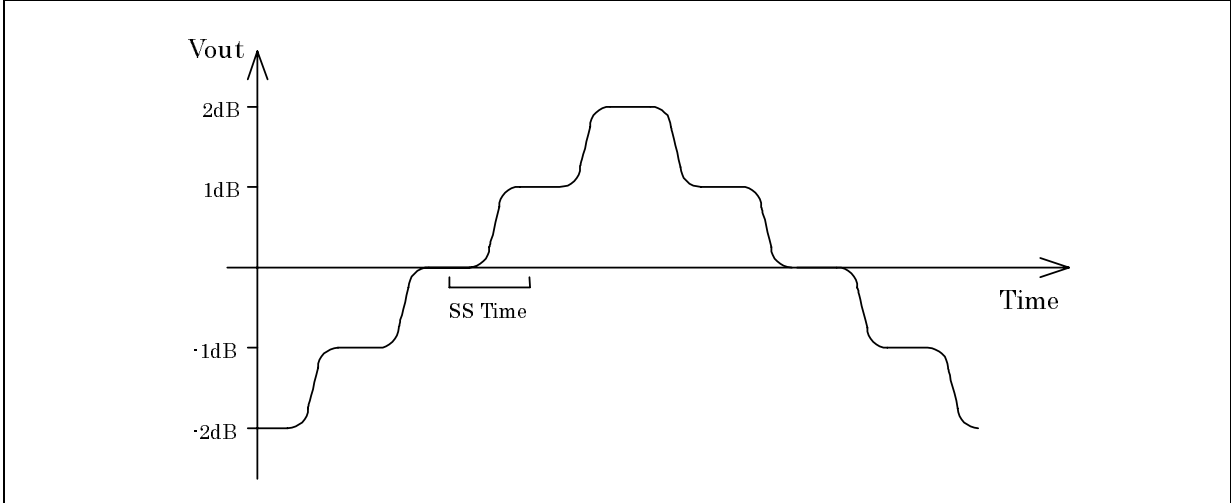

Note: For steps more than 1dB the SoftStep mode should be deactivated because it could generate a 1dB error during the blend-time.

1.7 Bass

There are three parameters programmable in the bass stage:

1.7.1 Attenuation

Figure 8 shows the attenuation as a function of frequency at a center frequency of 80Hz.

Figure 8. Bass Control @ fC = 80Hz, Q = 1

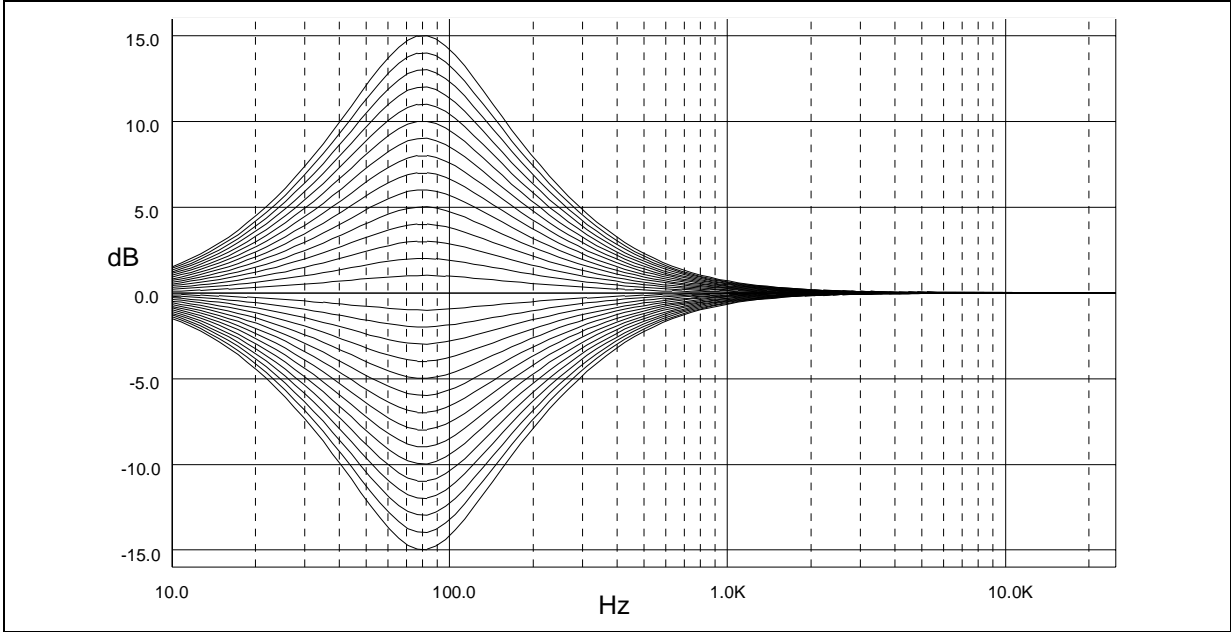

1.7.2 Center Frequency

Figure 9 shows the four possible center frequencies 60, 80, 100 and 200Hz.

Figure 9. Bass center Frequencies @ Gain = 15dB, Q = 1

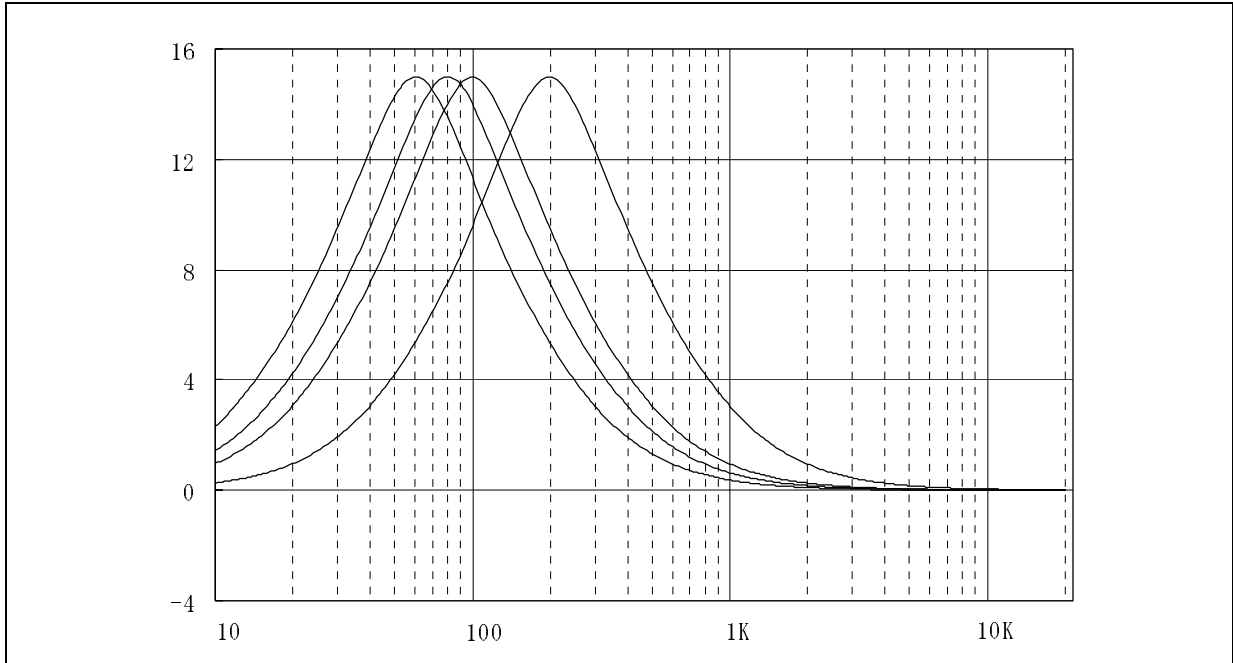

1.7.3 Quality Factors

Figure 10 shows the four possible quality factors 1, 1.25, 1.5 and 2.

Figure 10. Bass Quality factors @ Gain = 14dB, fC = 80Hz

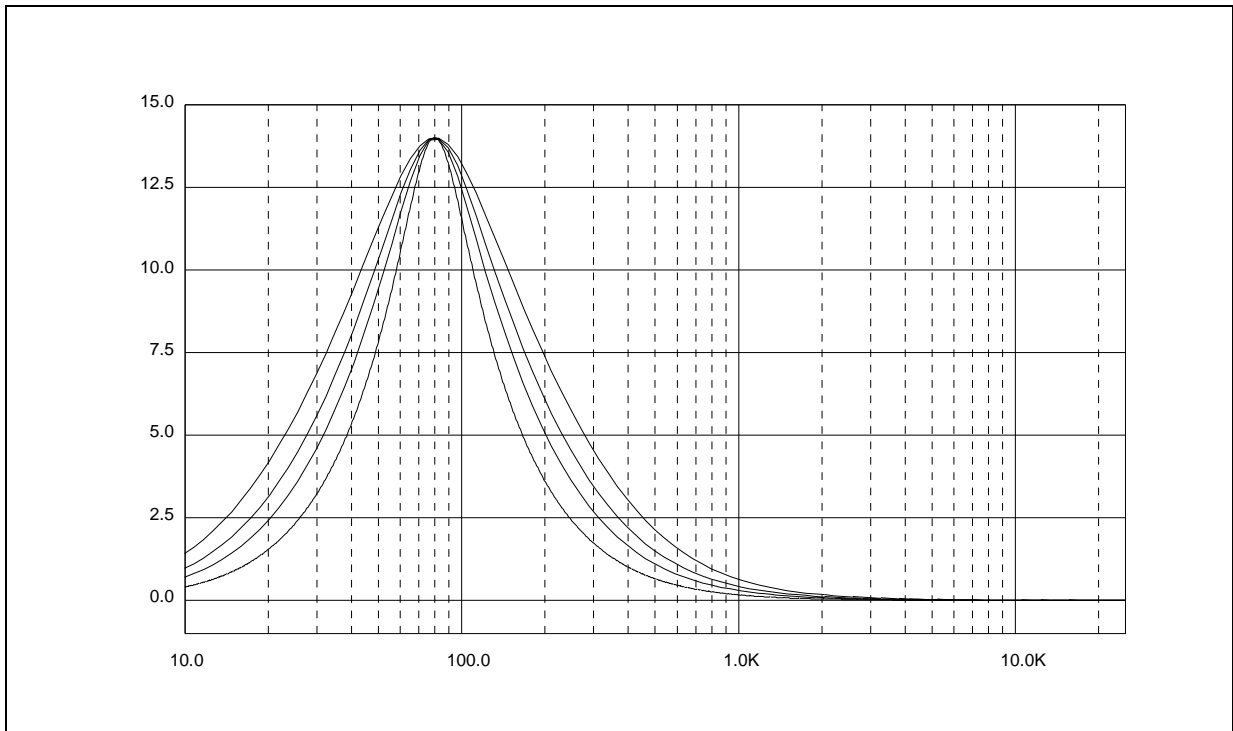

1.7.4 DC Mode

In this mode the DC-gain is increased by 4.4dB. In addition the programmed center frequency and quality factor is decreased by 25% which can be used to reach alternative center frequencies or quality factors.

Figure 11. Bass normal and DC Mode @ Gain = 14dB, $f_c = 80\text{Hz}$

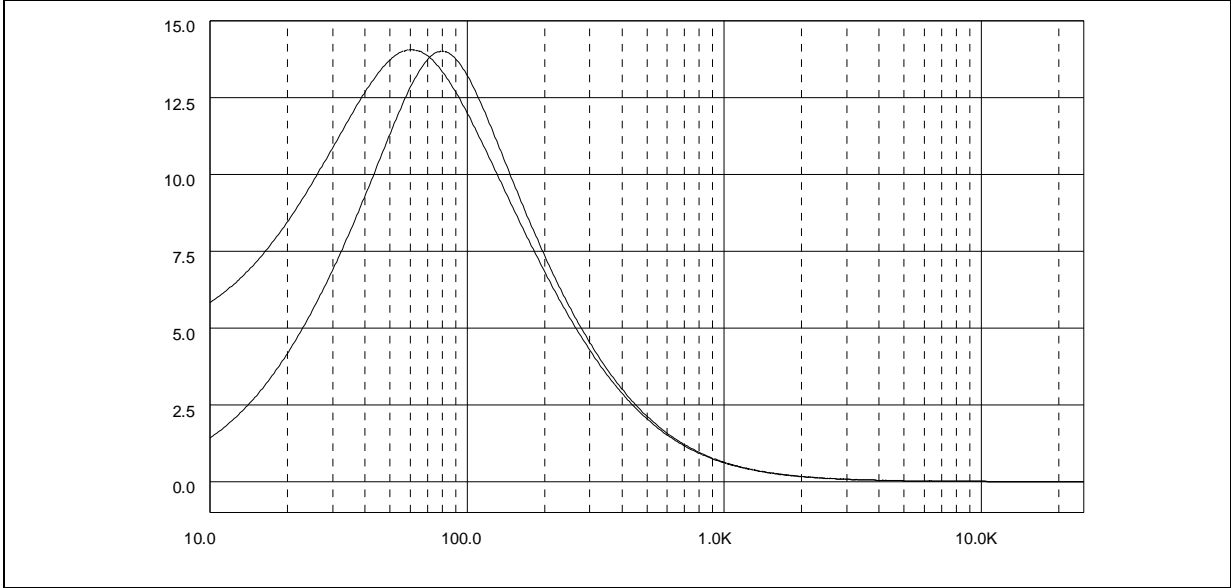

Note: The center frequency, Q and DC-mode can be set fully independently.

1.8 Treble

There are two parameters programmable in the treble stage:

1.8.1 Attenuation

Figure 12 shows the attenuation as a function of frequency at a center frequency of 17.5kHz.

Figure 12. Treble Control @ $f_c = 17.5\text{kHz}$

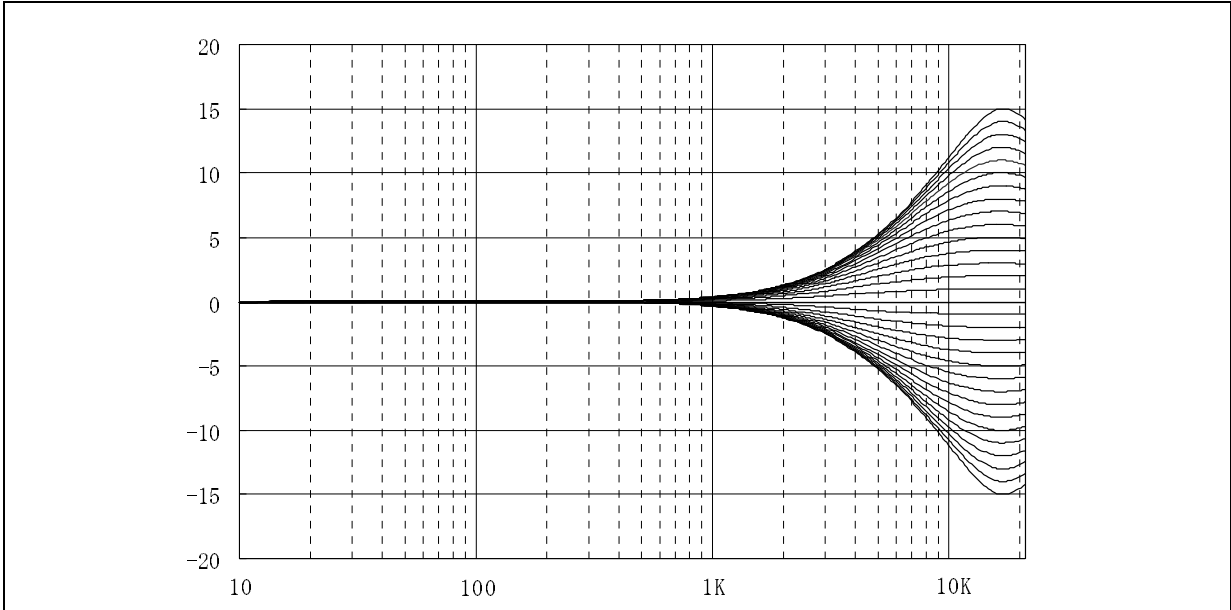

1.8.2 Center Frequency

Figure 13 shows the four possible center frequencies 10k, 12.5k, 15k and 17.5kHz.

Figure 13. Treble Center Frequencies @ Gain = 15dB

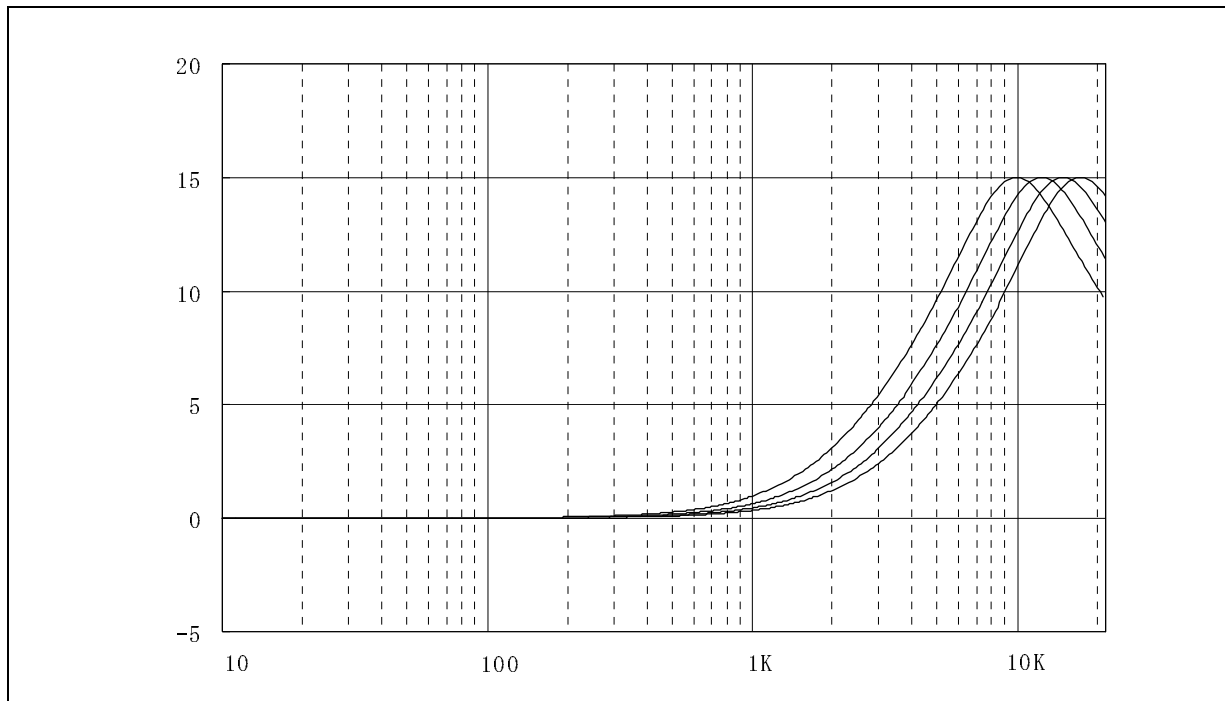

1.9 Speaker Attenuator

Due to practical aspects the steps in the speaker-attenuators are not linear over the full range. At attenuations more than 24dB the steps increase from 1.5dB to 10dB (please see data byte specification).

1.10 Subwoofer Attenuator

The Subwoofer output is a single ended stereo output. The attenuator is exactly the same like the other speakers.

2.0 I²C BUS INTERFACE

2.1 Interface Protocol

The interface protocol comprises:

- a start condition (S)
- a chip address byte (the LSB bit determines read / write transmission)
- a subaddress byte
- a sequence of data (N-bytes + acknowledge)
- a stop condition (P)
- the max. CLOCK SPEED is 500kbits/s

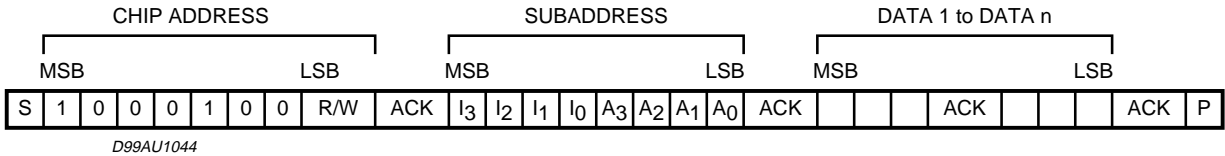

S = Start
 R/W = "0" -> Receive-Mode (Chip could be programmed by P)
 "1" -> Transmission-Mode (Data could be received by P)
 ACK = Acknowledge
 P = Stop

2.2 TRANSMITTED DATA (send mode)

MSB							LSB
X	X	X	X	X	X	X	SM

SM = Soft mute activated
 X = Not Used

The transmitted data is automatic updated after each ACK. Transmission can be repeated without new chipaddress.

2.3 Reset Condition

A Power-On-Reset is invoked if the Supply-Voltage is below than 3.5V. After that the following data is written automatically into the registers of all subaddresses :

MSB							LSB
1	1	1	1	1	1	1	0

The programming after POR is marked bold-face / underlined in the programming tables.
 With this programming all the outputs are muted to V_{REF} (V_{OUT}= V_{DD}/2).

Note : All the blank bits in the following tables are "don't care"-bits.

2.4 SUBADDRESS (receive mode)

MSB				LSB				FUNCTION
I ₃	I ₂	I ₁	I ₀	A ₃	A ₂	A ₁	A ₀	
0 1								Zero cross / Soft Mute ¹ Zero Cross available Soft Mute available
	0 1							AutoZero Remain ² off on
		0 1						Testmode ³ off on
			0 1					Auto-Increment Mode ⁴ off on
				0 0 0 0 0 0 0 0 1 1 1 1 1 1	0 0 0 0 1 1 1 0 0 0 0 1 1	0 0 1 1 0 1 1 0 0 1 0 0 0 0	0 1 0 1 0 1 1 0 1 0 1 1 0 0 1	Input Selector / Gain Loudness Volume Treble Bass Speaker attenuator LF / Bass Fc select Speaker attenuator RF Speaker attenuator LR Speaker attenuator RR Subwoofer attenuator LSW Subwoofer attenuator RSW SoftMute / Mixing Others selection Testing

¹ For more information see Soft Mute-section² For more information see AutoZero-section³ For more information see Test Programming block⁴ If this bit is set to "1", the subaddress is automatically incremented after the transmission of a data-byte.
Therefore a transmission of more than one byte without sending the new subaddress is possible.

2.5 DATA BYTE SPECIFICATION

2.5.1 Input Selector / Gain

MSB							LSB	FUNCTION
D7	D6	D5	D4	D3	D2	D1	D0	
					0	0	0	Source Selector
					0	0	1	Not used
					0	1	0	Single Ended 1
					0	1	1	Mute
					1	0	0	Single Ended 2
					1	0	1	Single Ended 4
					1	1	0	Single Ended 3
					1	1	1	Mute
								Beep
0	0	0	0	0				Input Gain
0	0	0	0	1				0dB
0	0	0	1	0				1dB
0	0	0	1	1				2dB
0	0	1	0	0				3dB
0	0	1	0	1				4dB
0	0	1	1	0				5dB
0	0	1	1	1				6dB
0	1	0	0	0				7dB
0	1	0	0	1				8dB
0	1	0	1	0				9dB
0	1	0	1	1				10dB
0	1	1	0	0				11dB
0	1	1	0	1				12dB
0	1	1	1	0				13dB
0	1	1	1	1				14dB
0	1	1	1	1				16dB
1	X	X	X	0				18dB
1	X	X	X	1				20dB

2.5.2 Loudness

MSB							LSB	LOUDNESS
D7	D6	D5	D4	D3	D2	D1	D0	
				0	0	0	0	Attenuation
				0	0	0	1	0 dB
				:	:	:	:	-1 dB
				1	1	1	0	:
				1	1	1	1	-14 dB
								-15 dB
	0	0	0					Filter / Center Frequency
		0	1					off(flat) 'D6 must be = 0'
		1	0					400Hz
		1	1					800Hz
								2.4KHz
	0							Shape
	1							Low Boost
								Low & High Boost
0								SoftStep-Volume
1								off
								on

Note 1: The attenuation is specified at high frequencies. Around the center frequency the value is different depending on the programmed attenuation (see Loudness-frequency-response).

2.5.3 Volume

MSB							LSB	ATTENUATION
D7	D6	D5	D4	D3	D2	D1	D0	
	0	0	0	0	0	0	0	Gain/Attenuation
	0	0	0	0	0	0	1	not allow
	0	0	0	0	0	1	0	+30.0dB
	0	0	0	0	0	1	1	+29.0dB
								:
	0	0	1	1	1	1	1	+1.0dB
	0	1	0	0	0	0	0	0.0dB
	0	1	0	0	0	0	1	- 1.0dB
	0	1	0	0	0	1	0	- 2.0dB
								:
	1	1	0	1	1	1	0	-78.0dB
	1	1	0	1	1	1	1	-79.0dB
	1	1	1	X	X	X	X	Mute
0								Must BE "0"

Note 2: It is not recommended to use a gain more than 20dB for system performance reason. In general, the max. gain should be limited by software to the maximum value, which is needed for the system.

2.5.4 Treble Programming

MSB							LSB	BASS & TREBLE PROGRAMMING
D7	D6	D5	D4	D3	D2	D1	D0	
				0	0	0	0	Treble Steps
				0	0	0	1	15dB
				0	0	1	0	14dB
				0	0	1	1	13dB
				0	1	0	0	12dB
				0	1	0	1	11dB
				0	1	1	0	10dB
				0	1	1	1	9dB
				1	0	0	0	8dB
				1	0	0	1	7dB
				1	0	1	0	6dB
				1	0	1	1	5dB
				1	1	0	0	4dB
				1	1	0	1	3dB
				1	1	1	0	2dB
				1	1	1	0	1dB
				1	1	1	1	0dB
			0					Mode
			1					Cut
								Boost
								Treble Center Frequency
X	0	0						10KHz
X	0	1						12.5KHz
X	1	0						15KHz
X	1	1						17.5KHz

2.5.5 Bass Programming

MSB							LSB	BASS & TREBLE PROGRAMMING
D7	D6	D5	D4	D3	D2	D1	D0	
				0	0	0	0	Bass Steps
				0	0	0	1	15dB
				0	0	1	0	14dB
				0	0	1	1	13dB
				0	1	0	0	12dB
				0	1	0	1	11dB
				0	1	1	0	10dB
				0	1	1	1	9dB
				1	1	1	1	8dB
				1	0	0	0	7dB
				1	0	0	1	6dB
				1	0	1	0	5dB
				1	0	1	1	4dB
				1	1	0	0	3dB
				1	1	0	1	2dB
				1	1	1	0	1dB
				1	1	1	1	0dB
			0					Mode
			1					Cut
								Boost
	0	0						Quality Factor
	0	1						1
	1	0						1.25
	1	1						1.5
								2
0								DC - Mode
1								Off
								On

Note 3: For more information please refer to section Bass description

2.5.6 Speaker Attenuator Left Front

MSB							LSB	ATTENUATION / BASS CF
D7	D6	D5	D4	D3	D2	D1	D0	
		0	0	0	0	0	0	Attenuation
		0	0	0	0	0	1	0 dB
		:	:	:	:	:	:	-1 dB
		0	1	0	1	1	1	-23 dB
		0	1	1	0	0	0	-24.5dB
		0	1	1	0	0	1	-26 dB
		0	1	1	0	1	0	-28 dB
		0	1	1	0	1	1	-30 dB
		0	1	1	1	0	0	-32 dB
		0	1	1	1	0	1	-35 dB
		0	1	1	1	1	0	-40 dB
		0	1	1	1	1	1	-50 dB
		1	X	X	X	X	X	Speaker Mute
0	0							Bass Center-Frequency
0	1							60Hz
1	0							80Hz
1	1							100Hz
								200Hz

2.5.7 Speaker Attenuator Right Front

MSB							LSB	ATTENUATION
D ₇	D ₆	D ₅	D ₄	D ₃	D ₂	D ₁	D ₀	
		0	0	0	0	0	0	Attenuation 0 dB
		0	0	0	0	0	1	-1 dB
		:	:	:	:	:	:	:
		0	1	0	1	1	1	-23 dB
		0	1	1	0	0	0	-24.5dB
		0	1	1	0	0	1	-26 dB
		0	1	1	0	1	0	-28 dB
		0	1	1	0	1	1	-30 dB
		0	1	1	1	0	0	-32 dB
		0	1	1	1	0	1	-35 dB
		0	1	1	1	1	0	-40 dB
		0	1	1	1	1	1	-50 dB
X	X	1	X	X	X	X	X	Speaker Mute

2.5.8 Speaker Attenuator Left Rear

MSB							LSB	ATTENUATION / Soft Step Time
D ₇	D ₆	D ₅	D ₄	D ₃	D ₂	D ₁	D ₀	
		0	0	0	0	0	0	Attenuation 0 dB
		0	0	0	0	0	1	-1 dB
		:	:	:	:	:	:	:
		0	1	0	1	1	1	-23 dB
		0	1	1	0	0	0	-24.5dB
		0	1	1	0	0	1	-26 dB
		0	1	1	0	1	0	-28 dB
		0	1	1	0	1	1	-30 dB
		0	1	1	1	0	0	-32 dB
		0	1	1	1	0	1	-35 dB
		0	1	1	1	1	0	-40 dB
		0	1	1	1	1	1	-50 dB
X	X	1	X	X	X	X	X	Speaker Mute

2.5.9 Speaker Attenuator Right Rear

MSB							LSB		ATTENUATION
D ₇	D ₆	D ₅	D ₄	D ₃	D ₂	D ₁	D ₀		
		0	0	0	0	0	0	0 dB	
		0	0	0	0	0	1	-1 dB	
		:	:	:	:	:	:	:	
		0	1	0	1	1	1	-23 dB	
		0	1	1	0	0	0	-24.5dB	
		0	1	1	0	0	1	-26 dB	
		0	1	1	0	1	0	-28 dB	
		0	1	1	0	1	1	-30 dB	
		0	1	1	1	0	0	-32 dB	
		0	1	1	1	1	0	-35 dB	
		0	1	1	1	1	0	-40 dB	
		0	1	1	1	1	1	-50 dB	
X	X	1	X	X	X	X	X	Speaker Mute	

2.5.10 Subwoofer Attenuator (Left & Right)

MSB							LSB		FUNCTION
D ₇	D ₆	D ₅	D ₄	D ₃	D ₂	D ₁	D ₀		
		0	0	0	0	0	0	0 dB	
		0	0	0	0	0	1	-1 dB	
		:	:	:	:	:	:	:	
		0	1	0	1	1	1	-23 dB	
		0	1	1	0	0	0	-24.5dB	
		0	1	1	0	0	1	-26 dB	
		0	1	1	0	1	0	-28 dB	
		0	1	1	0	1	1	-30 dB	
		0	1	1	1	0	0	-32 dB	
		0	1	1	1	0	1	-35 dB	
		0	1	1	1	1	0	-40 dB	
		0	1	1	1	1	1	-50 dB	
X	X	1	X	X	X	X	X	Speaker Mute	

2.5.11 SoftMute and Mixing

MSB							LSB	FUNCTION
D7	D6	D5	D4	D3	D2	D1	D0	
							0 1	Mute enable SoftMute disable SoftMute
					0 0 1 1	0 1 0 1		Mute/Zero Cross-Times 0.48ms 0.96ms 30.7ms / 9ms 122.8ms / 37ms
				0				Must BE "0"
		0 0 1 1	0 1 0 1					Mixing-Level (Main / Mix-Source) -12 / -2.5dB -6 / -6dB -3.5 / -9.6dB 0 / ∞
0 0 1 1	0 1 0 1							Beep Frequency 781Hz 1.56KHz Not allow 1.8KHz

2.5.12 Others

MSB							LSB	FUNCTION
D7	D6	D5	D4	D3	D2	D1	D0	
						X	0	AC-Coupling Internal pass
				1	1			Must be "1" Must be "1"
		0 0 1 1	0 1 0 1					Soft Step Time 0.68ms 1.26ms 2.52ms 5.04ms
	1							Must be "1" for Auto zero
0 1								Internal Beep Off ON

2.5.13 Testing

MSB							LSB	Testing
D7	D6	D5	D4	D3	D2	D1	D0	
		X X	X X	X X			0 1	Main-Testmode off on
		X X	X X	X X		0 1		Test-Multiplexer internal 200kHz Clock internal Bandgap Voltage
		X X	X X	X X	0 1			Clock external internal
1	1							must be "1"

Figure 14. TDA7409 Application Circuit

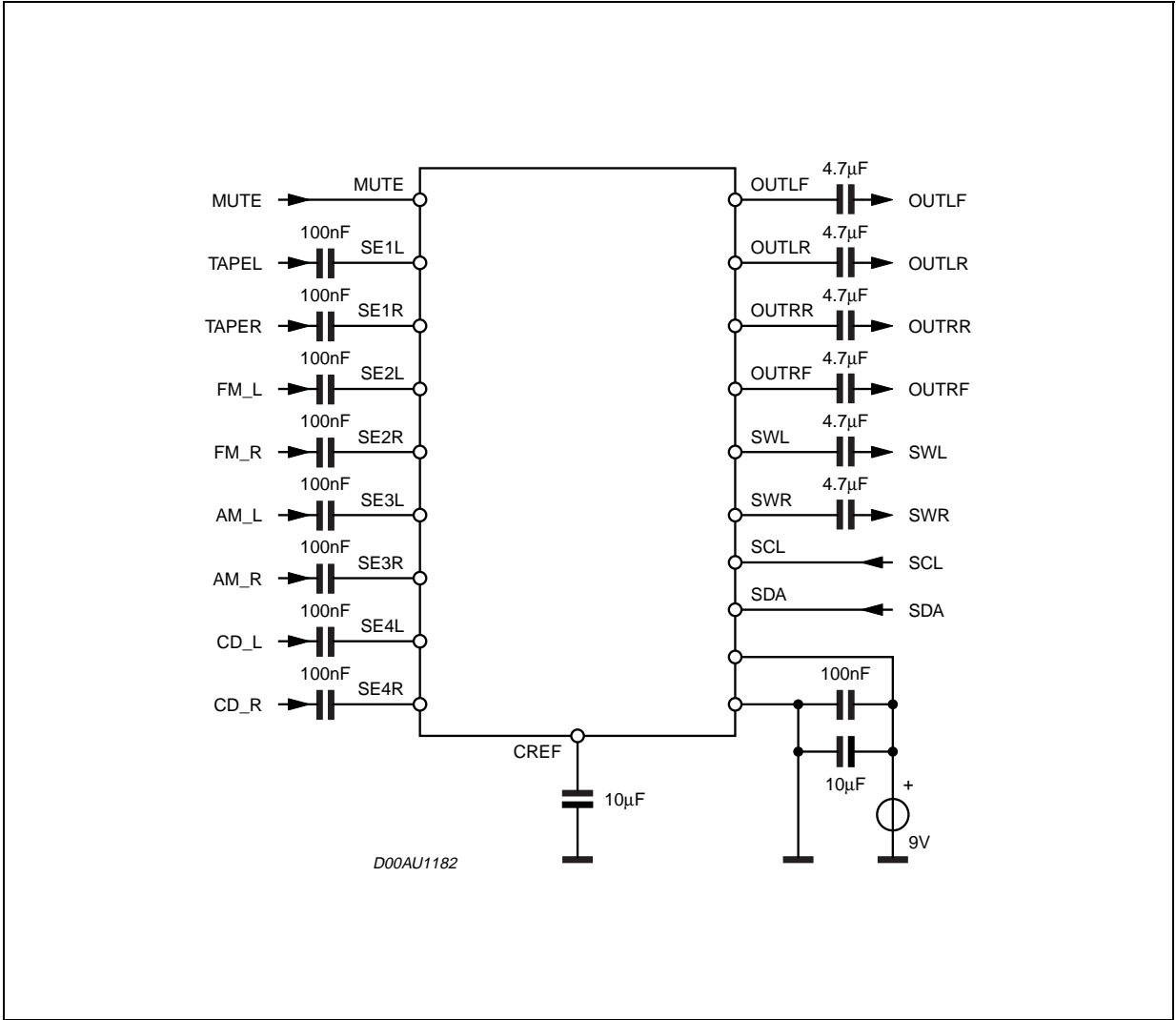

DIM.	mm			inch		
	MIN.	TYP.	MAX.	MIN.	TYP.	MAX.
A	2.35		2.65	0.093		0.104
A1	0.1		0.3	0.004		0.012
B	0.33		0.51	0.013		0.020
C	0.23		0.32	0.009		0.013
D	12.6		13	0.496		0.512
E	7.4		7.6	0.291		0.299
e		1.27			0.050	
H	10		10.65	0.394		0.419
h	0.25		0.75	0.010		0.030
L	0.4		1.27	0.016		0.050
K	0° (min.)8° (max.)					

OUTLINE AND MECHANICAL DATA

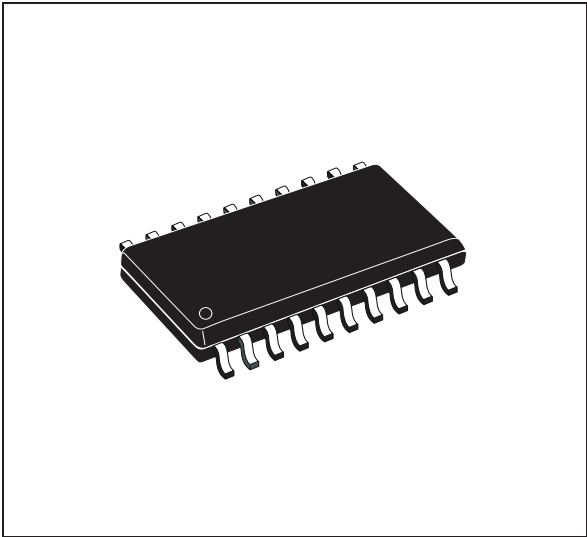

SO20

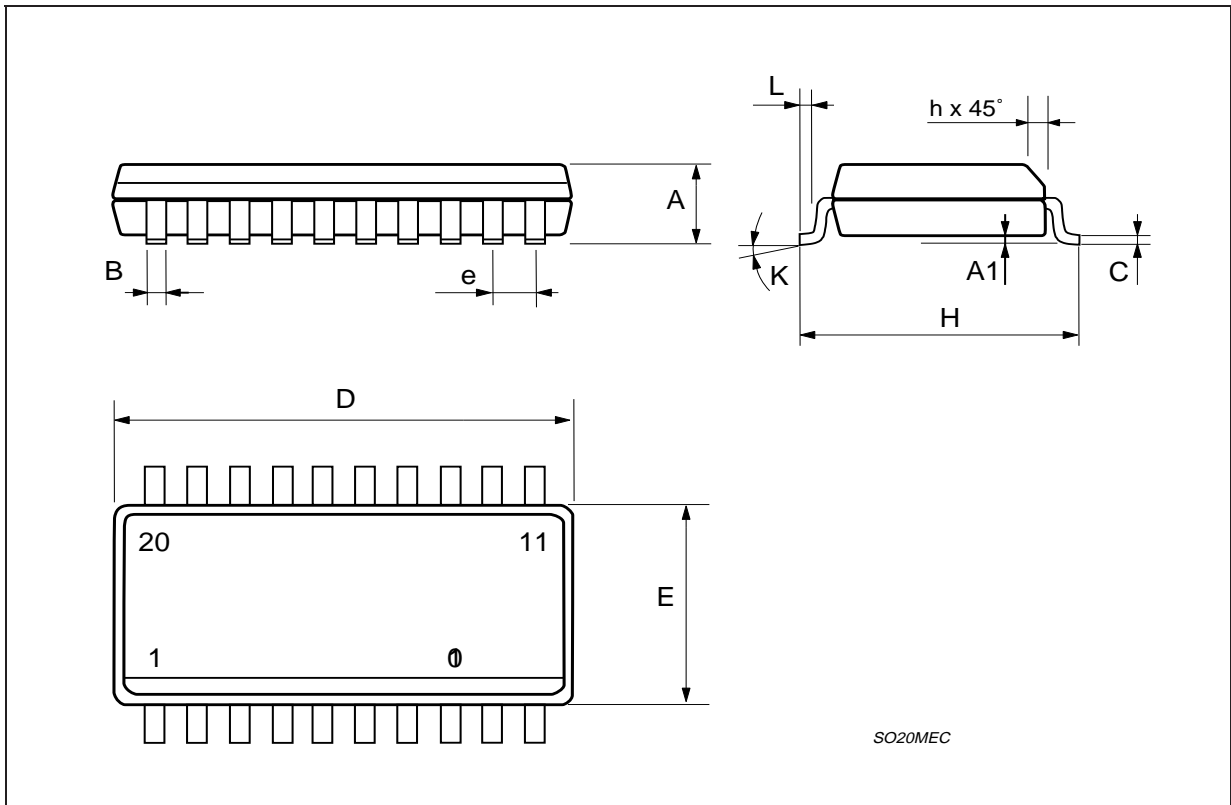

Information furnished is believed to be accurate and reliable. However, STMicroelectronics assumes no responsibility for the consequences of use of such information nor for any infringement of patents or other rights of third parties which may result from its use. No license is granted by implication or otherwise under any patent or patent rights of STMicroelectronics. Specifications mentioned in this publication are subject to change without notice. This publication supersedes and replaces all information previously supplied. STMicroelectronics products are not authorized for use as critical components in life support devices or systems without express written approval of STMicroelectronics.

The ST logo is a registered trademark of STMicroelectronics.
All other names are the property of their respective owners

© 2003 STMicroelectronics - All rights reserved

STMicroelectronics GROUP OF COMPANIES

Australia - Belgium - Brazil - Canada - China - Czech Republic - Finland - France - Germany - Hong Kong - India - Israel - Italy - Japan -
Malaysia - Malta - Morocco - Singapore - Spain - Sweden - Switzerland - United Kingdom - United States
www.st.com